

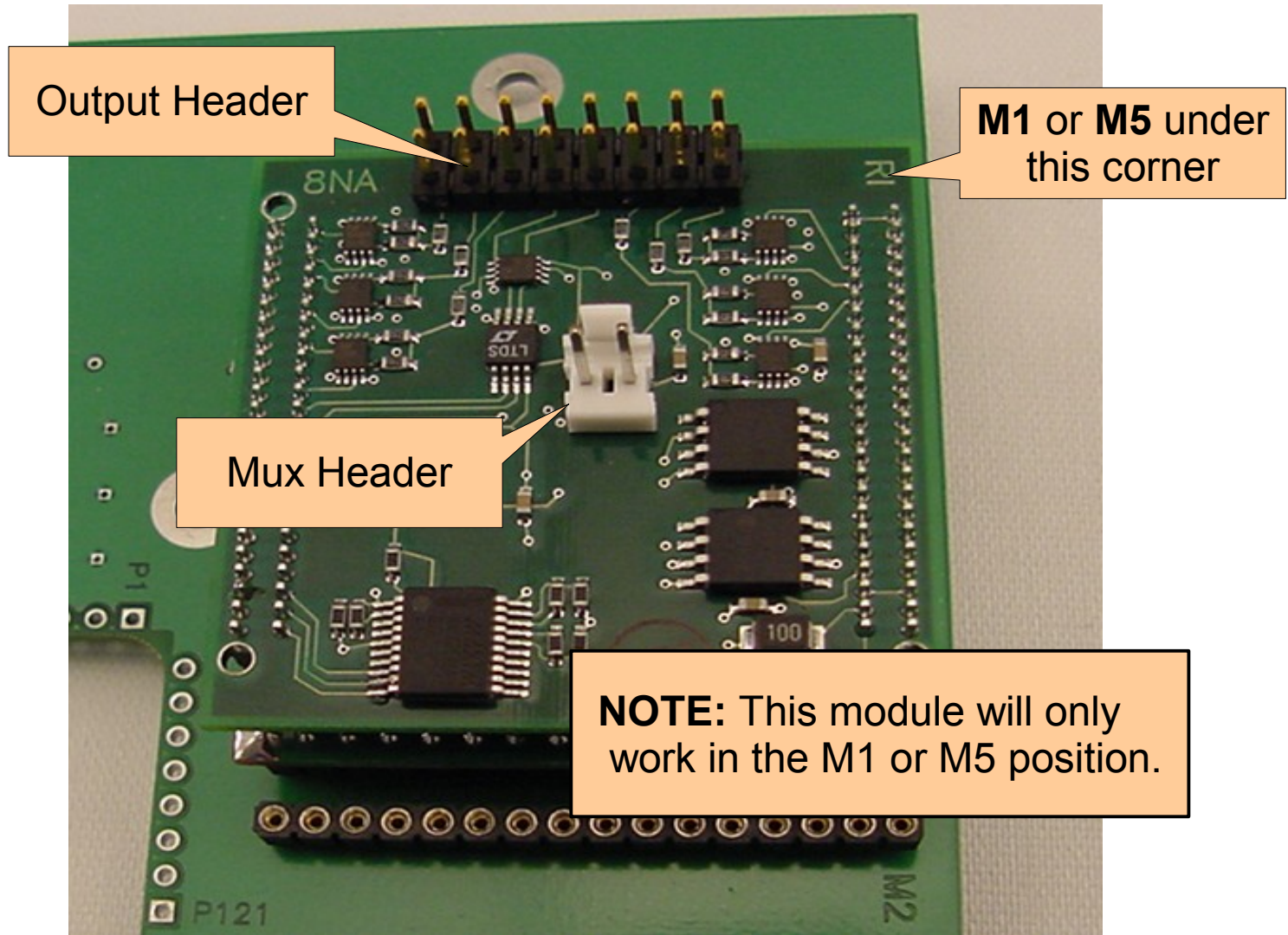

# Module Installation RIK0127A High Speed Digital



Output Header

M1 or M5 under  
this corner

Mux Header

**NOTE:** This module will only  
work in the M1 or M5 position.



# Header Designations

P1-P3 and P6 - P8 can be set for clock, data, strobe, or static.

P9 - P16 = GND

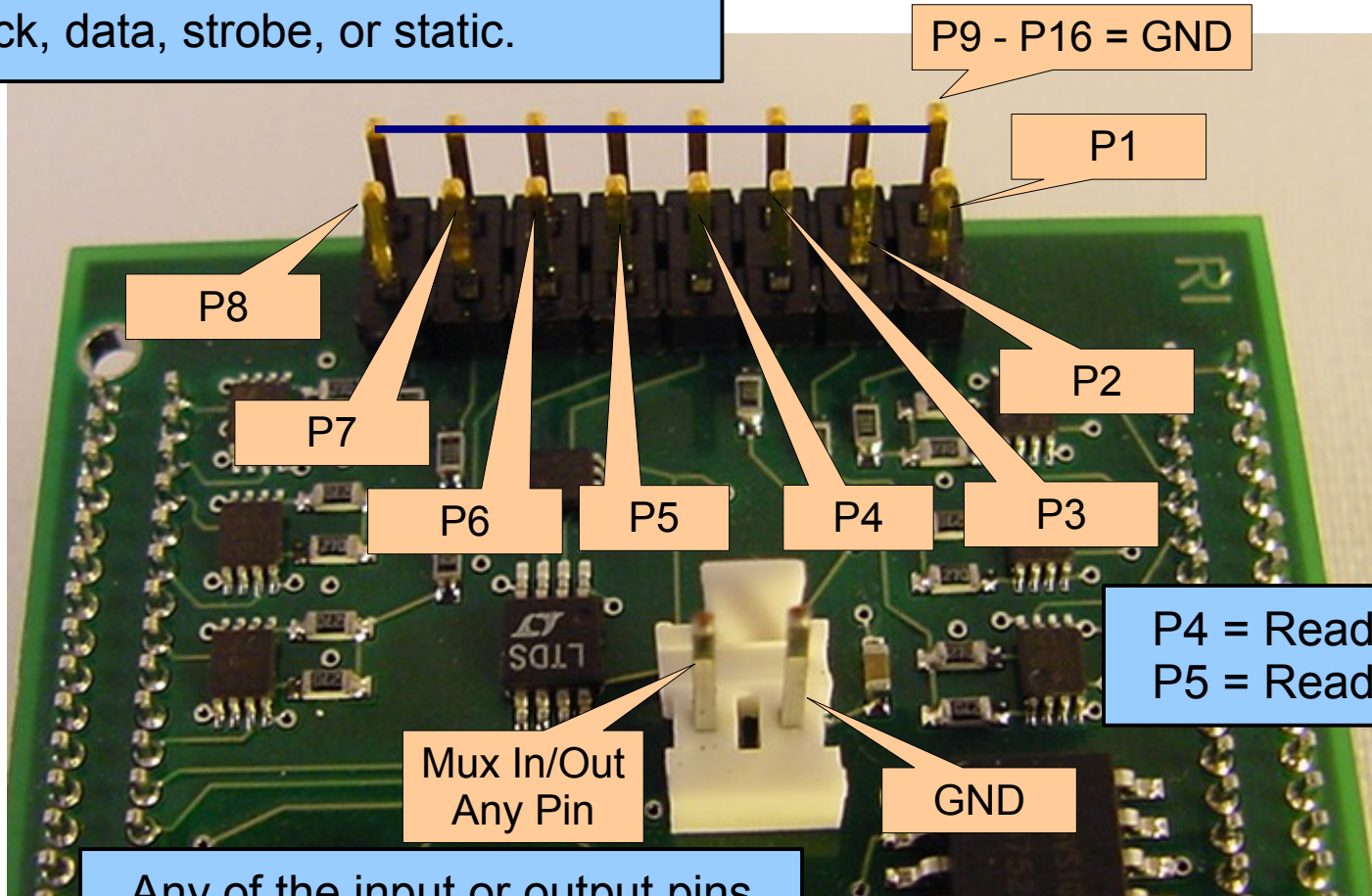

P1

P8

P7

P6

P5

P4

P2

P3

P4 = Read A  
P5 = Read B

Mux In/Out  
Any Pin

GND

Any of the input or output pins  
can be routed to the mux pin.



# Configuring the RIK0127A High Speed Digital Module

1. Perform a system startup and confirm that the fixture is automatically activated.
2. Go to the main Test Environment Window and select “Test” and from the pull down menu “Equip...”.
3. When the Equipment Pool window opens, select “Control Modules”  
A “Module Browser” window will open.

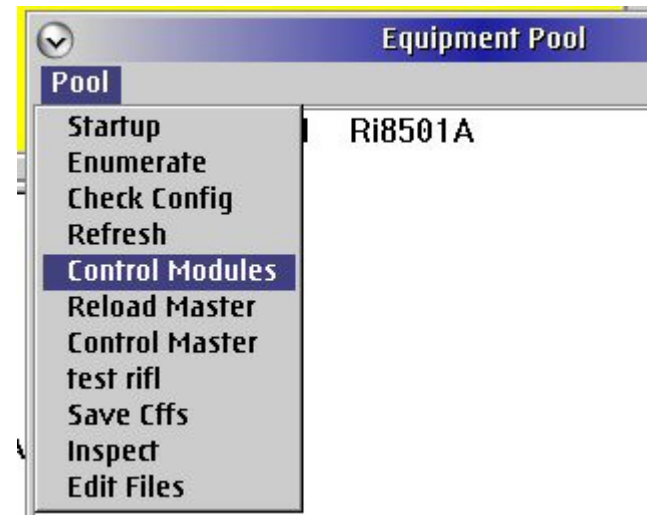



# Adding the Module

4. Scroll down the listing in the Module Browser and **highlight** “Y00065A1”.

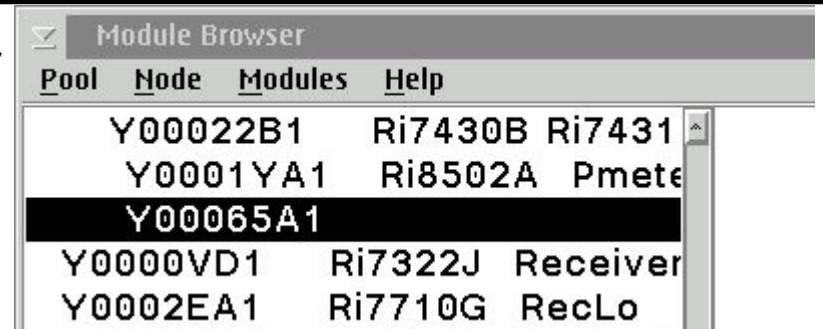

5. Next go to the “Modules” selection on the main menu of this window and select “Add Module”.

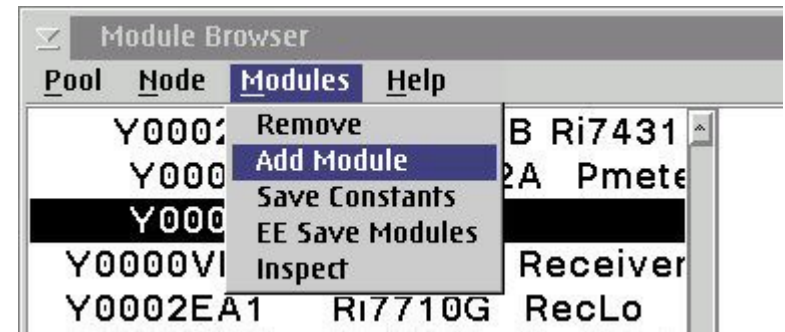

6. A selection window will pop up. Select “Y2000H1A” and then “Select”.

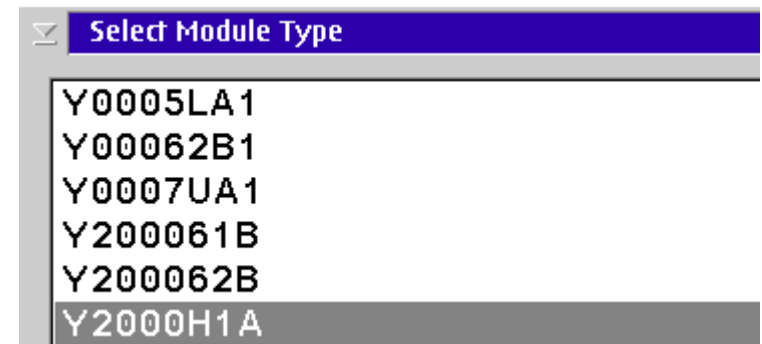



# Adding the Module

- You will be prompted to provide the module location. Change the default location to “M5” if you are using the module in the M5 position. Leave it in the default state if you are using the M1 location on the carrier then select “OK” from the prompt.

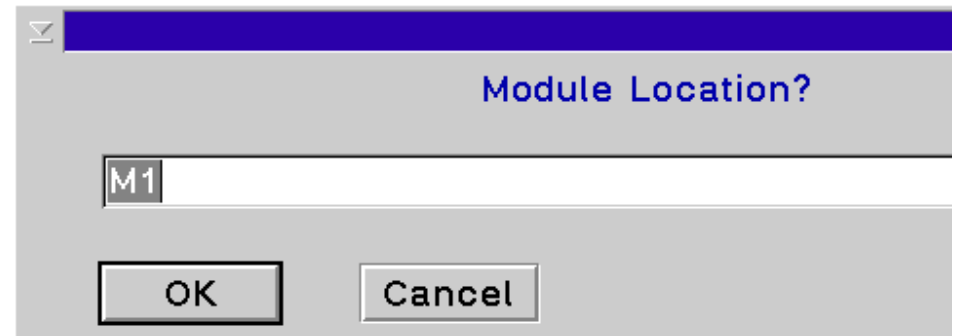

**NOTE:** This module will only work in M1 or M5 locations!

- Highlight** the “M1 Y2000H1A” that will appear in the right hand column of the window. Several buttons will appear in the bottom half. Find the one named “Program”. Check to make sure it has Y18NA11A contained in its field.

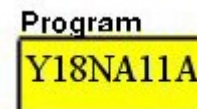
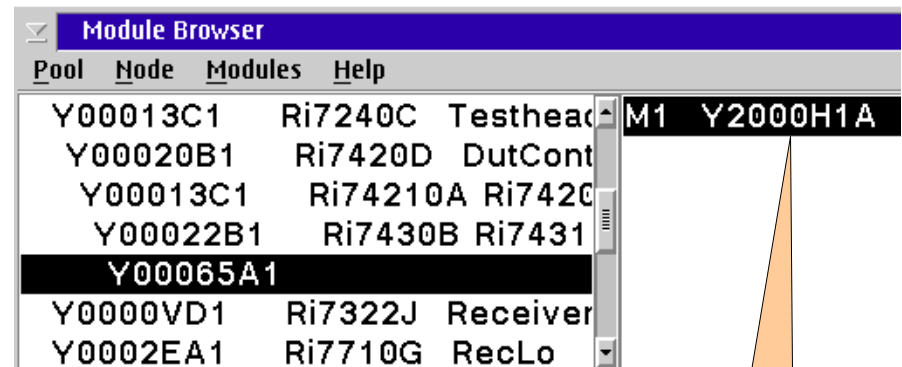



# Saving The Module Adding the Instrument

9. **Highlight** “Y00065A1” and “M1 Y2000H1A” in the Module Browser. Go to the Module Browser main menu and select “EE Save Modules”. Answer “Yes” to the prompt.
10. **Highlight** “Y00065A1” and “M1 Y2000H1A” in the Module Browser.
11. Go to the Module Browser main menu and select “Node” and then “Add Inst”.
12. Select “RI74315C” and then “select”.

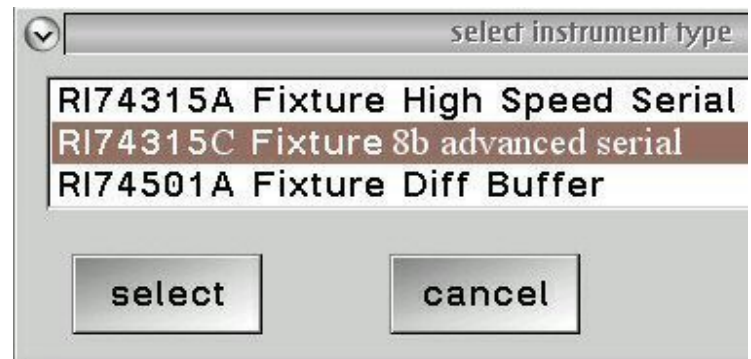
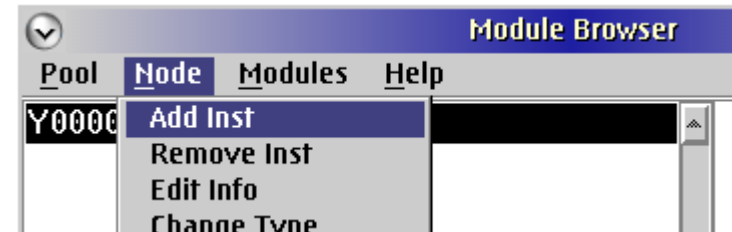



# Adding the Instrument

12. When prompted for the “Instrument Name” choose “OK”. This will allow the default “FixtureDigital1” to be entered.

13. You will then be prompted to enter the “Module Location Integer”. Enter 1 for M1 or 5 for M5 and select “OK”

**NOTE:** This module will only work in M1 or M5 locations!

14. **Highlight** “Y00065A1” and “M1 Y2000H1A” in the Module Browser.

15. Go to the Module Browser main menu and select “Node” and then “EE Save Node Info” from the pull down menu. Respond “Yes” to the prompt.

Instrument Name

FixtureDigital1

OK Cancel

Module Location Integer

1

OK Cancel

Module Browser

| Pool  | Node | Modules             | Help |
|-------|------|---------------------|------|
| Y0006 |      | Add Inst            |      |
|       |      | Remove Inst         |      |
|       |      | Edit Info           |      |
|       |      | Change Type         |      |
|       |      | Import Cff          |      |
|       |      | Roll Serial Numbers |      |
|       |      | Save CFF            |      |
|       |      | EE read Node Info   |      |
|       |      | EE Save Node Info   |      |



# Checking The Changes

15. Close the Module Browser and the equipment pool windows and then perform a system startup.

Carrier and Instrument Number

| Pool     | Node     | Modules  | Help        |
|----------|----------|----------|-------------|
| Y00013C1 | Ri7240C  | Testhead | M1 Y2000H1A |
| Y00020B1 | Ri7420D  | DutCont  |             |
| Y00013C1 | Ri74210A | Ri7420   |             |
| Y00022B1 | Ri7430B  | Ri7431   |             |
| Y00065A1 | Ri74315C |          |             |
| Y0000VD1 | Ri7322J  | Receiver |             |
| Y0002EA1 | Ri7710G  | RecLo    |             |

Program Name: Y18NA11A

Location: M1

Name: M1

Module and Location

Program Name

Location/Name are equal

16. Deactivate the fixture and perform a system startup. Return to the Module Browser window and observe to see if the full configuration has been saved.



# Module Buttons

## Device DB

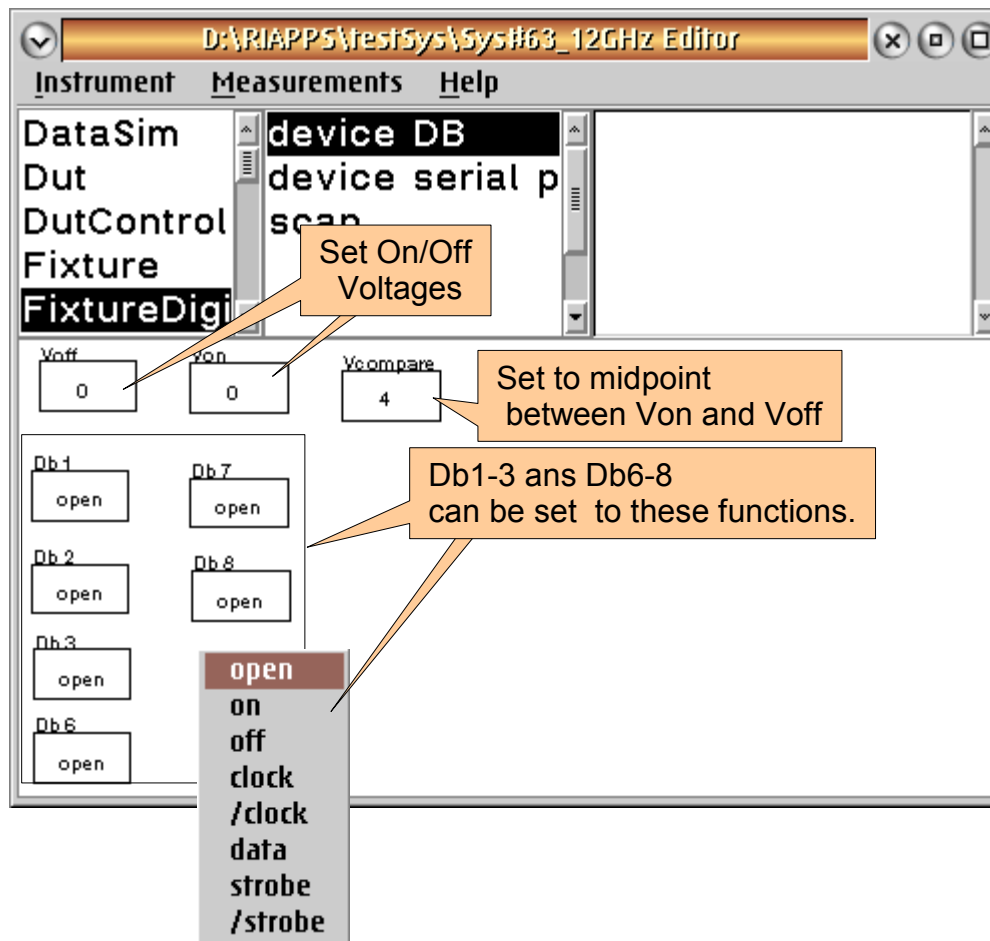



# Module Buttons

## Device Serial Patterns

The screenshot shows a software interface for configuring device serial patterns. The window title is "D:\RIAPPS\TestSys\System#63\_12GHz Editor". The main area is divided into several sections:

- Left Panel:** A list of modules including DataSim, Dut, DutControl, Fixture, and FixtureDigi.
- Right Panel:** A list of device identifiers including "device DB", "device serial p", and "scan".
- Configuration Fields:**
  - Serial Type:** None
  - Serial Size:** 0
  - Vector Type:** none
  - Serial Read Size:** 0
  - Serial Read Start:** 0
  - Measure Mode:** None
  - Measure Pin:** None
  - Vector Clock Period:** 25 n
  - Serial Write:** (empty field)
- External Callouts:**
  - A callout box labeled "DUT" with options "local" and "None" points to the "Serial Type" field.
  - A callout box labeled "none" with options "Scan", "StdFormat", and "Map" points to the "Vector Type" field.
  - A callout box labeled "Read Monitor" with the option "None" points to the "Measure Mode" field.
  - A callout box labeled "None" with options "DB1" through "DB8" points to the "Measure Pin" field.
  - An orange callout box labeled "Clock cycles before read start" points to the "Serial Read Start" field.
  - An orange callout box labeled "For local writes" points to the "Serial Write" field.



# Module Buttons

## Scan

**normal**  
inverted

**normal**

**off**

on fail  
on read

**Results of scan on ReadA (Db4)**

**None**  
shiftDsp

**None**

**Results of scan on ReadB (Db5)**

**-1.5**  
-1.0  
-0.5  
0  
0.5  
1.0  
1.5  
2.0  
2.5

**Clock pulses to skip before read**



# Displaying Scan Results

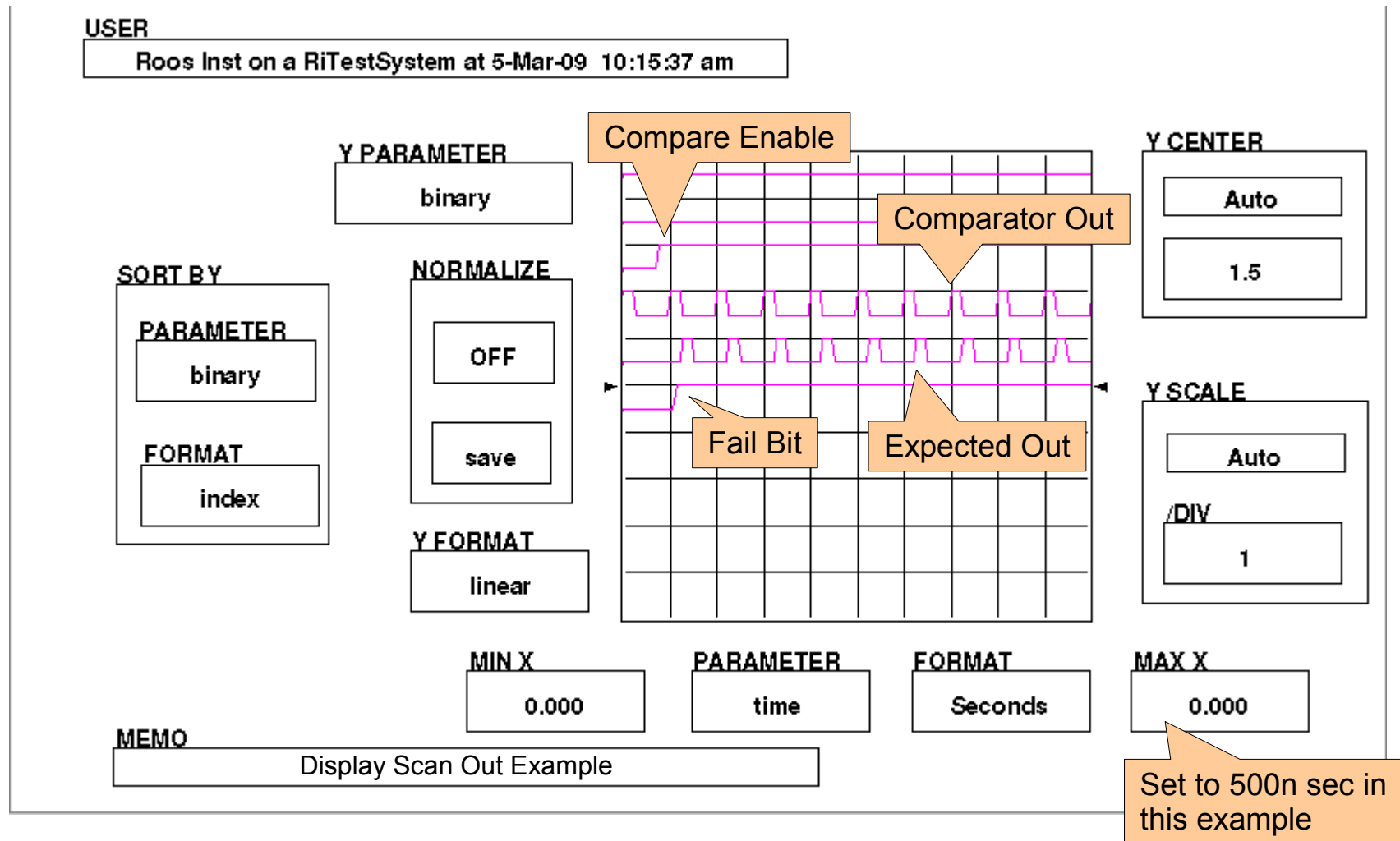



# Preparing to Display Scan Results Measurement

```
RIK0127A w/ limits: Sys
File Edit Test Plan Tester Limits Options Help Debug
<DISABLED>Test: P5 Toggle Low
<DISABLED>Test: P5 Toggle High
Test Section: Scan Tests (Unoptimized)
Conditional Statement
Section Defaults
Test: Scan Test Pin 4 Pass
Test: Test
Test: Scan Test Pin 4 Fail
<DISABLED>Test: Scan Test Pin 5
<DISABLED>Test Section: Read Test 4
```

Scan file compared to

Clock pulses to skip before read. Used to compensate for DUT signal delay.

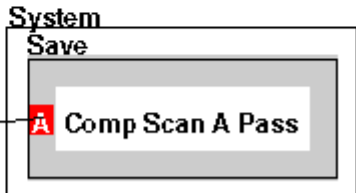
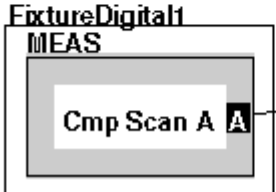
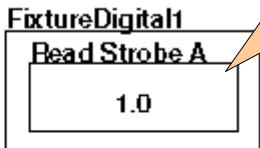
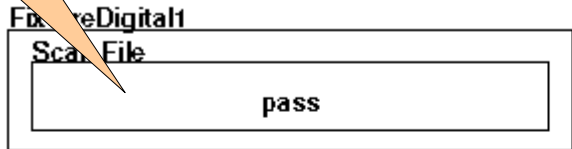

**Note:**  
Before the Scan Results can be displayed "Cmp Scan" must be performed



# Measure and Display Fail Data

RIK0127A w/ limits: System Check FAIL

File Edit Test Plan Tester Limits Options Help Debug

<DISABLED>Test: P5 Toggle Low  
<DISABLED>Test: P5 Toggle High  
Test Section: Scan Tests (Unoptimized)  
Conditional Statement  
Section Defaults  
Test: Scan Test Pin 4 Pass  
**Test: Test**  
Test: Scan Test Pin 4 Fail  
<DISABLED>Test: Scan Test Pin 5  
<DISABLED>Test Section: Read Test

Return the results based on ReadA (Db4). Assumes Cmp Scan A was done. Traces are defined as:

- Bottom = Fail Bit
- Second from Bottom = Read Expected
- Third from Bottom = Comparator Output
- Fourth from Bottom = Compare Enable.

Make sure to use a line type of "binary"

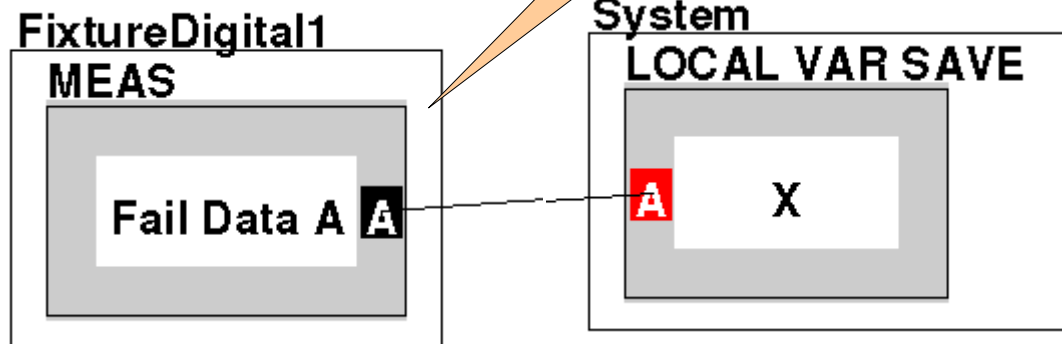



# Loading a Scan File<sub>1</sub>

Once the carrier board is configured a scan file can be loaded into the modules memory. Here are the steps required to do that.

- Go to the Tester Configuration window and highlight the fixture digital.
- Choose the “Load Patterns” from the button list.

```
Fixture, RIK0127A Transient 9  
FixtureDigital1, RI74315C Fixture 8b  
gainCompression, RI7800D Gain Corr  
intermod, RI7805C Intermod Inst 0  
IQMeter, RI7806A IQ Meter 0
```

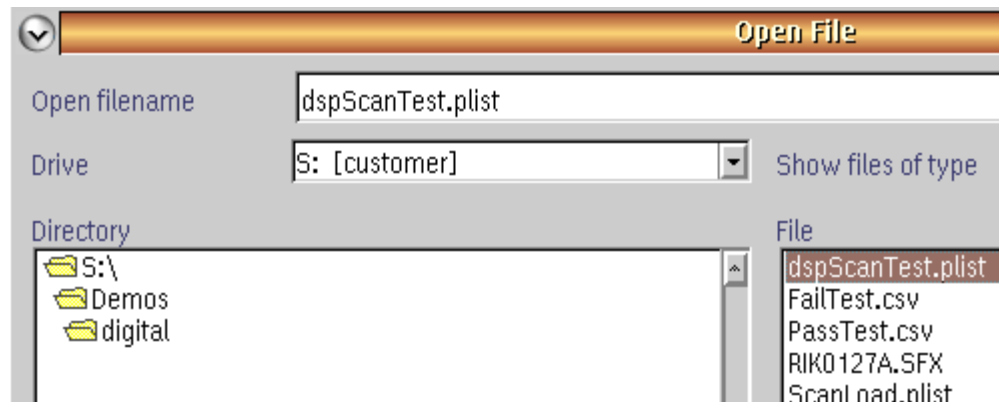

- Choose the .plist file that represents the scan file(s) that you want to load.



# Loading a Scan File<sub>2</sub>

- Once you have selected the pattern to load the tester will ask if you want to erase existing patterns.

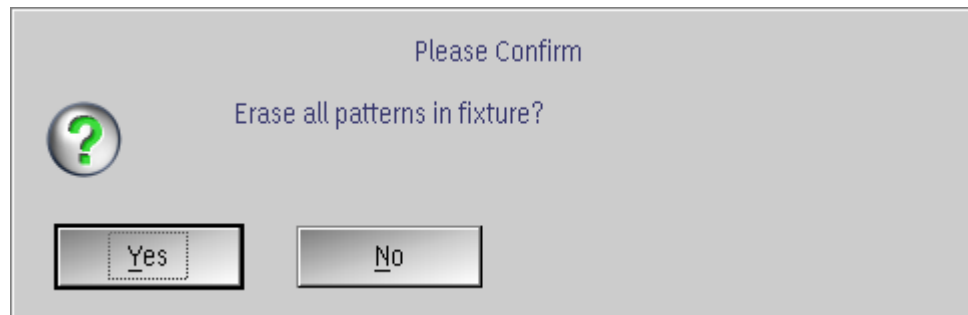

- You will then need to wait for the eraser and loading of the new patterns.

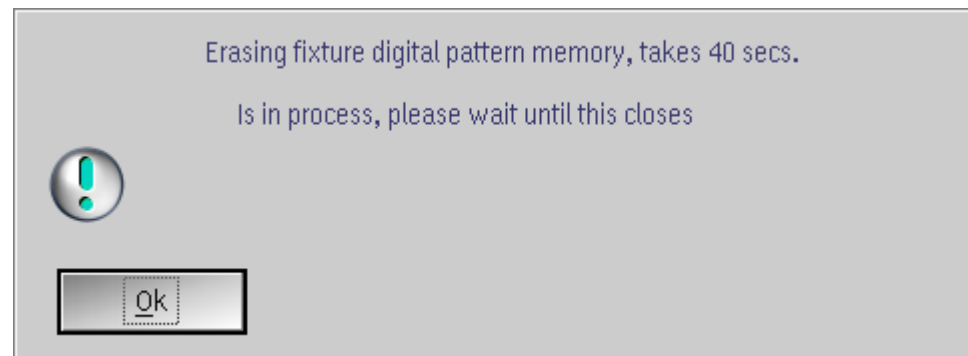





# Plist Example

